

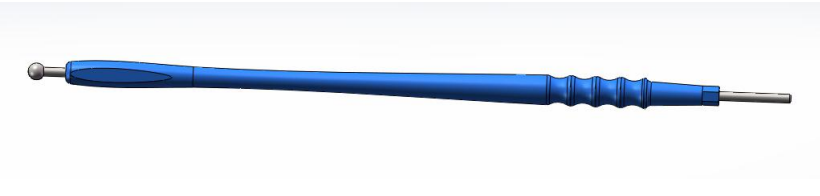

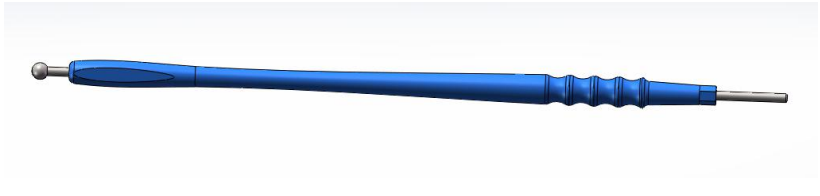
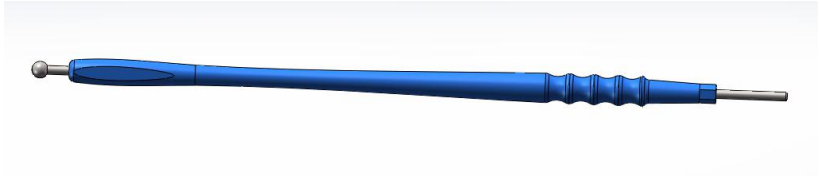
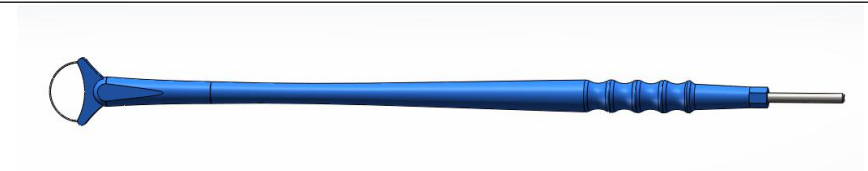
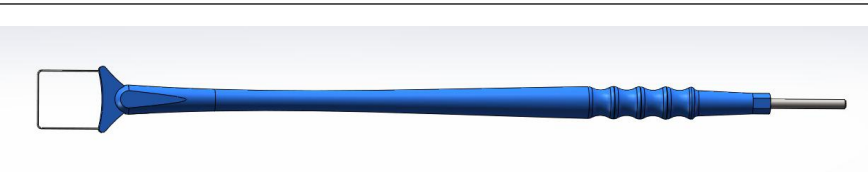
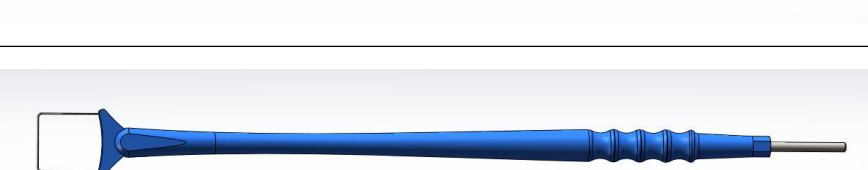

()

| | | (mm) | (mm) | (mm) |
|-----------|--|------|------|------|
| B3030150R |  | 3.0 | 3.0 | 150 |
| B3030150H |  | 3.0 | 3.0 | 150 |
| B5050150R |  | 5.0 | 5.0 | 150 |

| | | | | |
|-----------|--|-----|-----|-----|
| B5050150H |  | 5.0 | 5.0 | 150 |
| U0215150R |  | 0.2 | 15 | 150 |
| U0215150H |  | 0.2 | 15 | 150 |
| U0210150R |  | 0.2 | 10 | 150 |
| U0210150H |  | 0.2 | 10 | 150 |

| | | | | |
|-----------|---|-----|----|-----|
| U0205150R |  | 0.2 | 5 | 150 |
| U0205150H |  | 0.2 | 5 | 150 |
| R0210150R |  | 0.2 | 10 | 150 |
| R0210150H |  | 0.2 | 10 | 150 |
| F0215150R |  | 0.2 | 15 | 150 |

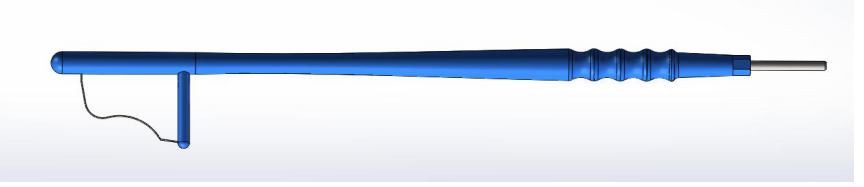
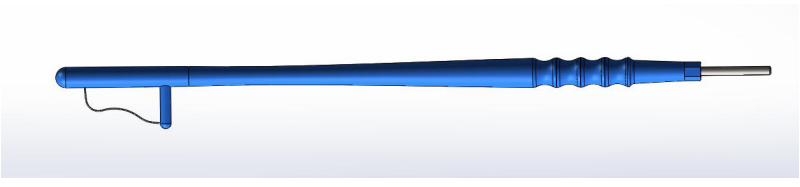
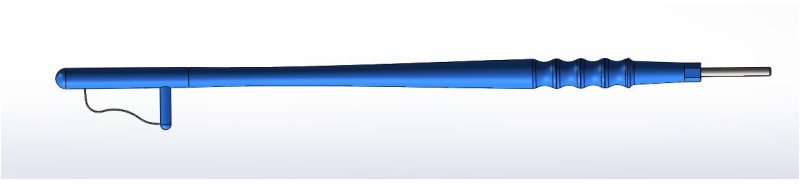
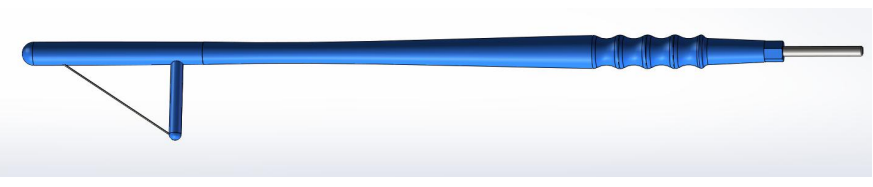
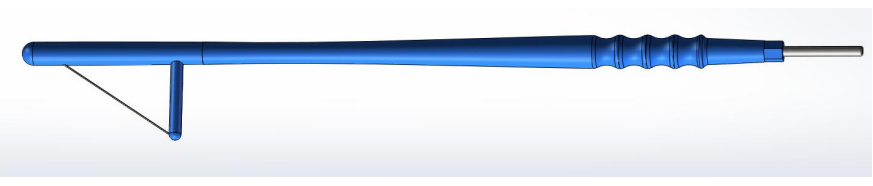
| | | | | |
|-----------|--|-----|----|-----|
| F0215150H |  | 0.2 | 15 | 150 |
| F0210150R |  | 0.2 | 10 | 150 |
| F0210150H |  | 0.2 | 10 | 150 |
| T0219150R |  | 0.2 | 19 | 150 |
| T0219150H |  | 0.2 | 19 | 150 |

| | | | | |
|-----------|--|-----|----|-----|
| T0213150R |  | 0.2 | 13 | 150 |
| T0213150H |  | 0.2 | 13 | 150 |
| N0210040R |  | 0.2 | 10 | 40 |
| N0210060R |  | 0.2 | 10 | 60 |
| N0210080R |  | 0.2 | 10 | 80 |







| | | | | |
|-----------|--|-----|----|----|
| NO210040H |  | 0.2 | 10 | 40 |
| NO210060H |  | 0.2 | 10 | 60 |
| NO210080H |  | 0.2 | 10 | 80 |
| NO410040R |  | 0.4 | 10 | 40 |
| NO410060R |  | 0.4 | 10 | 60 |







Beijing Greenland Co., Ltd







Add: Building 2, Liando U Vally, No.18, Yanxin South Rd, Fangshan District, Beijing, China





Tel: +86 13264500477 www.greenlandmed.com export@greenlandmed.com





| | | | | |
|------------|---|-----|----|----|
| N0410080R |  | 0.4 | 10 | 80 |
| N0410040H |  | 0.4 | 10 | 40 |
| N0410060H |  | 0.4 | 10 | 60 |
| N0410080H |  | 0.4 | 10 | 80 |
| N0210040R1 |  | 0.2 | 10 | 40 |

| | | | | |
|------------|--|-----|----|----|
| N0210060R1 |  | 0.2 | 10 | 60 |
| N0210080R1 |  | 0.2 | 10 | 80 |
| N0210040H1 |  | 0.2 | 10 | 40 |
| N0210060H1 |  | 0.2 | 10 | 60 |
| N0210080H1 |  | 0.2 | 10 | 80 |
| N0410040R1 |  | 0.4 | 10 | 40 |

| | | | | |
|------------|--|-----|----|----|
| N0410060R1 |  | 0.4 | 10 | 60 |
| N0410080R1 |  | 0.4 | 10 | 80 |
| N0410040H1 |  | 0.4 | 10 | 40 |
| N0410060H1 |  | 0.4 | 10 | 60 |
| N0410080H1 |  | 0.4 | 10 | 80 |
| T0210040R1 |  | 0.2 | 10 | 40 |

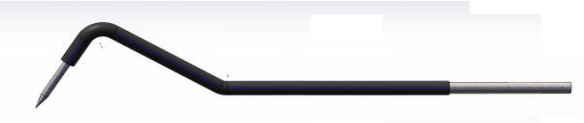

| | | | | |
|------------|---|-----|----|----|
| T0210060R1 |  | 0.2 | 10 | 60 |
| T0210080R1 |  | 0.2 | 10 | 80 |
| T0210040H1 |  | 0.2 | 10 | 40 |
| T0210060H1 |  | 0.2 | 10 | 60 |
| T0210080H1 |  | 0.2 | 10 | 80 |
| L0210040R |  | 0.2 | 10 | 40 |

| | | | | |
|-----------|--|-----|----|----|
| L0210060R |  | 0.2 | 10 | 60 |
| L0210080R |  | 0.2 | 10 | 80 |
| L0210040H |  | 0.2 | 10 | 40 |
| L0210060H |  | 0.2 | 10 | 60 |
| L0210080H |  | 0.2 | 10 | 80 |









| | | | | |
|-----------|--|-----|----|----|
| C1010040R |  | 1.0 | 10 | 40 |
| C1010060R |  | 1.0 | 10 | 60 |
| C1010080R |  | 1.0 | 10 | 80 |
| C1010040H |  | 1.0 | 10 | 40 |
| C1010060H |  | 1.0 | 10 | 60 |
| C1010080H |  | 1.0 | 10 | 80 |









| | | | | |
|-----------|--|-----|-----|----|
| B2525040R |  | 2.5 | 2.5 | 40 |
| B2525060R |  | 2.5 | 2.5 | 60 |
| B2525080R |  | 2.5 | 2.5 | 80 |
| B3535040R |  | 3.5 | 3.5 | 40 |
| B3535060R |  | 3.5 | 3.5 | 60 |



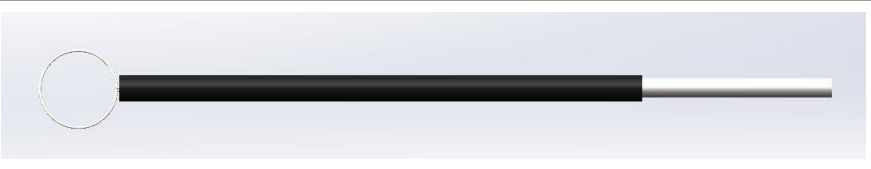





| | | | | |
|------------|--|-----|-----|----|
| B3535080R |  | 3.5 | 3.5 | 80 |
| B3535040H |  | 3.5 | 3.5 | 40 |
| B3535060H |  | 3.5 | 3.5 | 60 |
| B3535080H |  | 3.5 | 3.5 | 80 |
| C1612040R1 |  | 1.6 | 12 | 40 |









| | | | | |
|------------|--|-----|----|----|
| C1612060R1 |  | 1.6 | 12 | 60 |
| C1612080R1 |  | 1.6 | 12 | 80 |
| C1612040H1 |  | 1.6 | 12 | 40 |
| C1612060H1 |  | 1.6 | 12 | 60 |
| C1612080H1 |  | 1.6 | 12 | 80 |





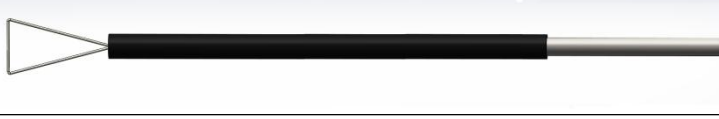

| | | | | |
|-----------|--|-----|---|----|
| N0208040R |  | 0.2 | 8 | 40 |
| N0208060R |  | 0.2 | 8 | 60 |
| N0208080R |  | 0.2 | 8 | 80 |
| N0208040H |  | 0.2 | 8 | 40 |
| N0208060H |  | 0.2 | 8 | 60 |
| N0208080H |  | 0.2 | 8 | 80 |

| | | | | |
|-----------|--|-----|----|----|
| C1612040R |  | 1.6 | 12 | 40 |
| C1612060R |  | 1.6 | 12 | 60 |
| C1612080R |  | 1.6 | 12 | 80 |
| C1612040H |  | 1.6 | 12 | 40 |
| C1612060H |  | 1.6 | 12 | 60 |
| C1612080H |  | 1.6 | 12 | 80 |
| L0207040R |  | 0.2 | 7 | 40 |
| L0207060R |  | 0.2 | 7 | 60 |

| | | | | |
|-----------|--|-----|----|----|
| L0207080R |  | 0.2 | 7 | 80 |
| L0207040H |  | 0.2 | 7 | 40 |
| L0207060H |  | 0.2 | 7 | 60 |
| L0207080H |  | 0.2 | 7 | 80 |
| D0210040R |  | 0.2 | 10 | 40 |
| D0210060R |  | 0.2 | 10 | 60 |
| D0210080R |  | 0.2 | 10 | 80 |
| D0210040H |  | 0.2 | 10 | 40 |

| | | | | |
|-----------|--|-----|----|----|
| D0210060H |  | 0.2 | 10 | 60 |
| D0210080H |  | 0.2 | 10 | 80 |
| N0207040R |  | 0.2 | 7 | 40 |
| N0207060R |  | 0.2 | 7 | 60 |
| N0207080R |  | 0.2 | 7 | 80 |
| N0207040H |  | 0.2 | 7 | 40 |
| N0207060H |  | 0.2 | 7 | 60 |
| N0207080H |  | 0.2 | 7 | 80 |
| T0210040R |  | 0.2 | 10 | 40 |

| | | | | |
|-----------|--|-----|-----|----|
| T0210060R |  | 0.2 | 10 | 60 |
| T0210080R |  | 0.2 | 10 | 80 |
| T0210040H |  | 0.2 | 10 | 40 |
| T0210060H |  | 0.2 | 10 | 60 |
| T0210080H |  | 0.2 | 10 | 80 |
| B3535040R |  | 3.5 | 3.5 | 40 |
| B3535060R |  | 3.5 | 3.5 | 60 |
| B3535080R |  | 3.5 | 3.5 | 80 |

| | | | | |
|------------|--|-----|-----|-----|
| B3535040H |  | 3.5 | 3.5 | 40 |
| B3535060H |  | 3.5 | 3.5 | 60 |
| B3535080H |  | 3.5 | 3.5 | 80 |
| K0220070H1 |  | 0.2 | 20 | 70 |
| K0220070H |  | 0.2 | 20 | 70 |
| N0503115R |  | 0.5 | 3 | 115 |

